

# 惠比壽 1124 1月度

① 身頃 17.50/m (1枚)  
(衿 3色) 夏顔 1個 + 帽子 1枚

② 船<sub>巾</sub> 150/m (1枚) 紐 

③ 圍周 150/m = 等辺三角形 2枚  
目玉 2ル

④ 鎖り 竿 150/m 1枚  
釣 紐 150/m 1枚

⑤ 身頃の衿 (7.5 x 150/m) 1枚  
紐 30/2 x 70/m 1枚

恵比寿と鯛

24年1月度

24. 1. 12. (木)

材料内訳

1) 恵比寿 本体 白禪紙 17.5%角	1枚	2) 鯛 左禪紙 15%角 $\frac{1}{2}$ 等辺三角形	2枚
" 衿 3% $\times$ 7% 3色	各2枚 1枚	" 目 2-1 丸	2組
" 顔首 3% 至	1組		
" 帽子 5%角 白禪紙	1枚	3) 船体 毛紙合板 15%角	1枚
" 結衣紐 11% (長さ)	1本	" 船 2.5% $\times$ 10%	1枚
" 袴 白禪紙 7.5% $\times$ 15%	1枚	" 友禪紙 3%角	1枚
" " 3% $\times$ 7%	1枚	" 毛 7%	1本
" 足手 新紙 (白染) 6% 4%角	足2枚 手2枚		
" 釣竿 15% (長さ)	1本	大色紙	1枚
" 手 (長さ) 17% (長さ)	1本		

平成二十四年度

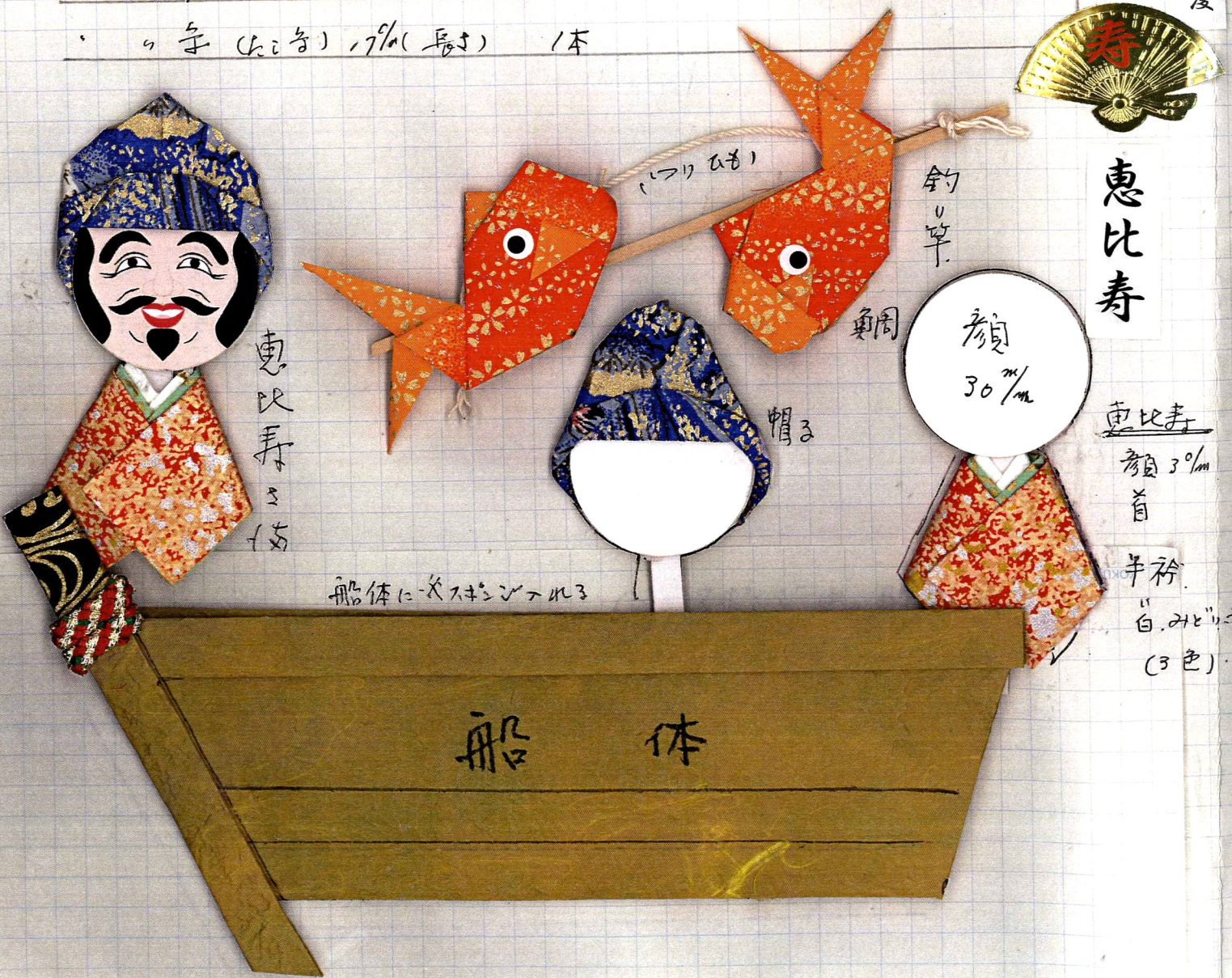

恵比寿

恵比寿  
顔 3%  
首  
袴  
白・赤  
(3色)

船体

恵比寿

釣竿

鯛

帽子

船体に次紙を貼る

(1) 恵比寿

本体 (17.5°/m角)

衿明子

後身頃  
前身頃

26

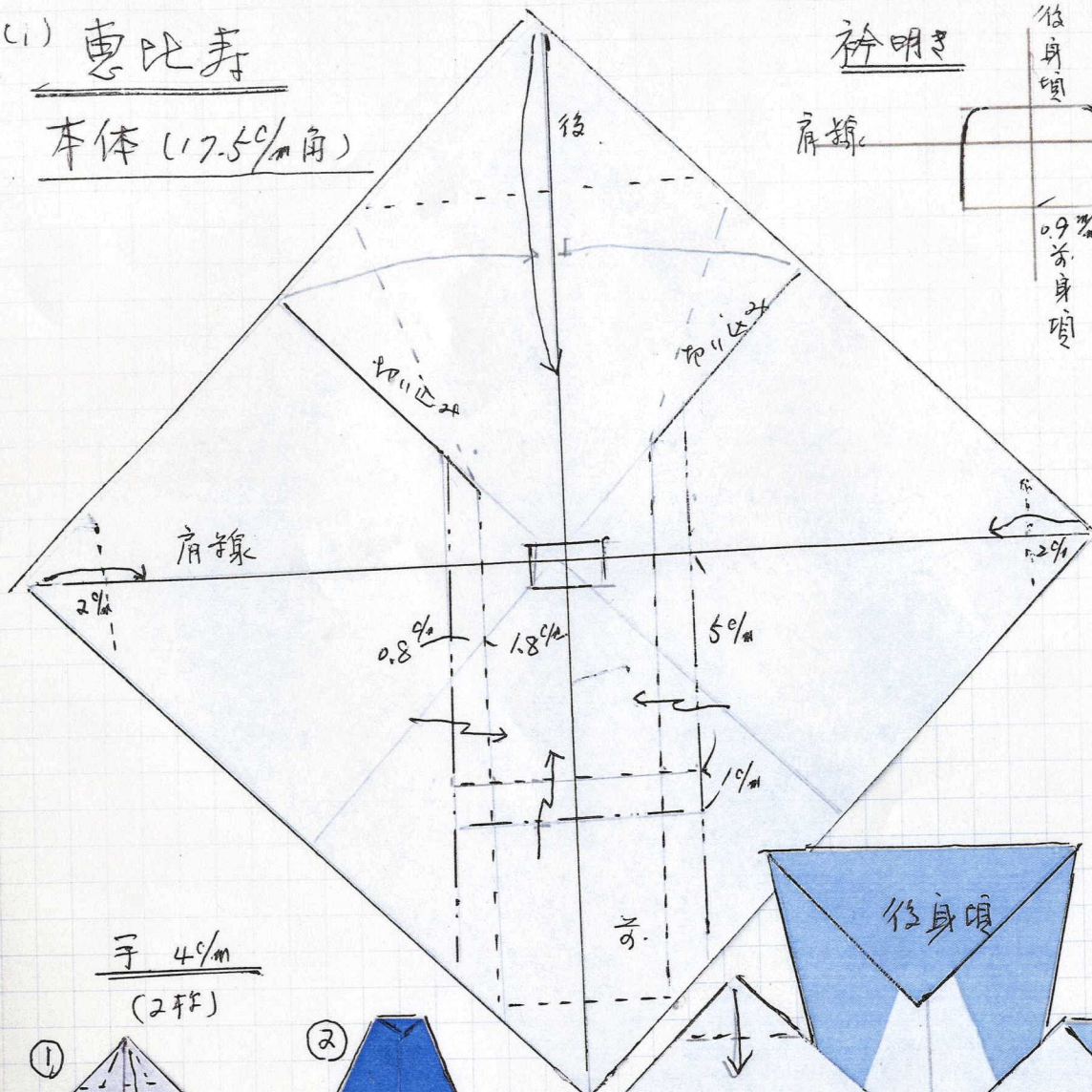

肩線

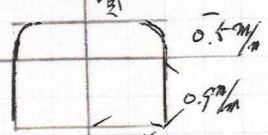

手 4°/m  
(2折)

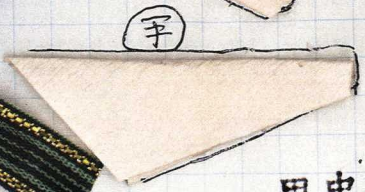
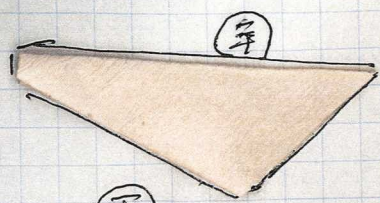
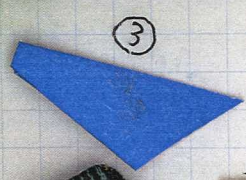
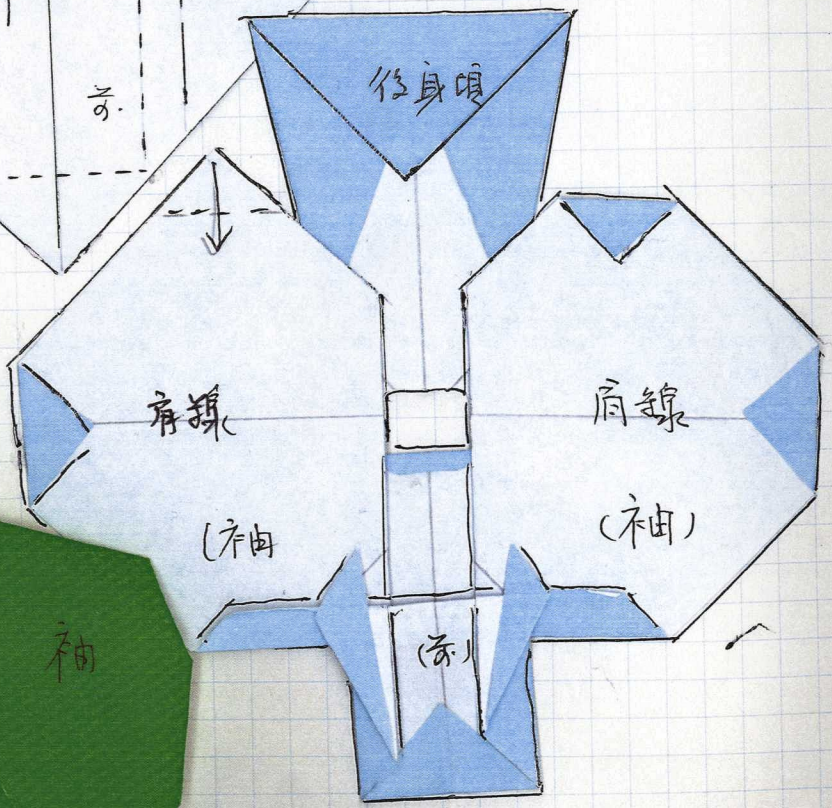
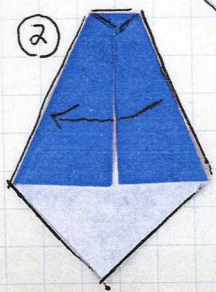
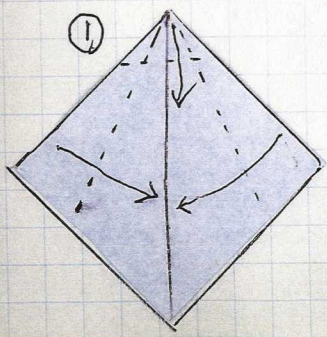

田中静子

H 24. 1. 20. (全)

袴

7.5<sup>cm</sup> x 15<sup>cm</sup> (1枚)

2<sup>cm</sup> x 7<sup>cm</sup> (1枚)

①

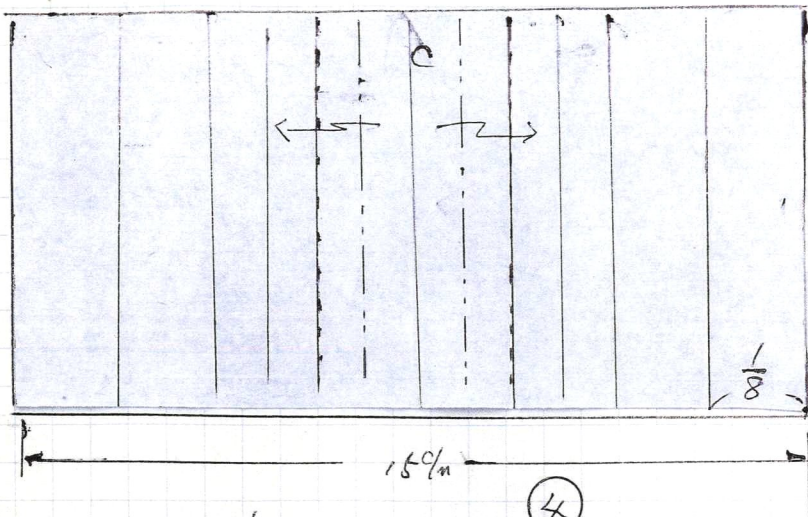

②

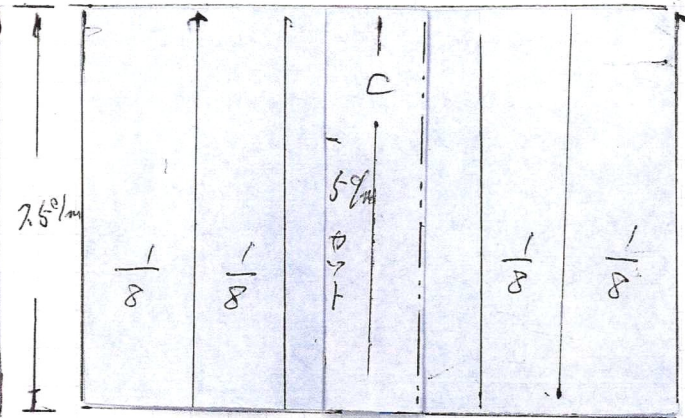

④

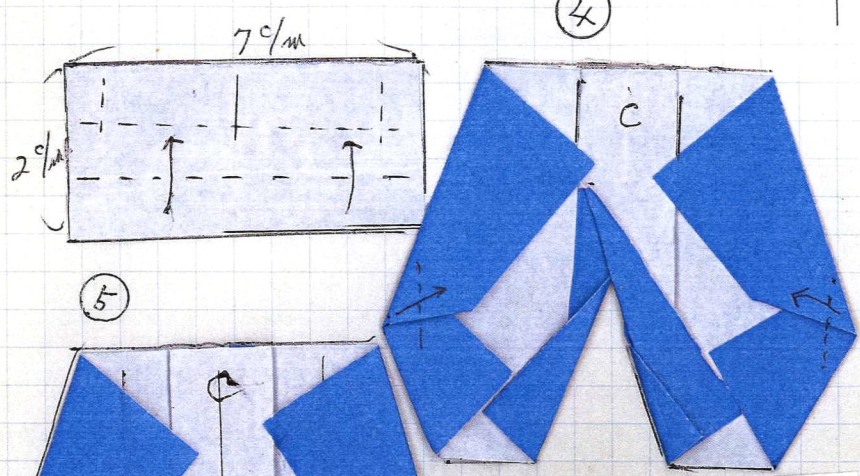

③

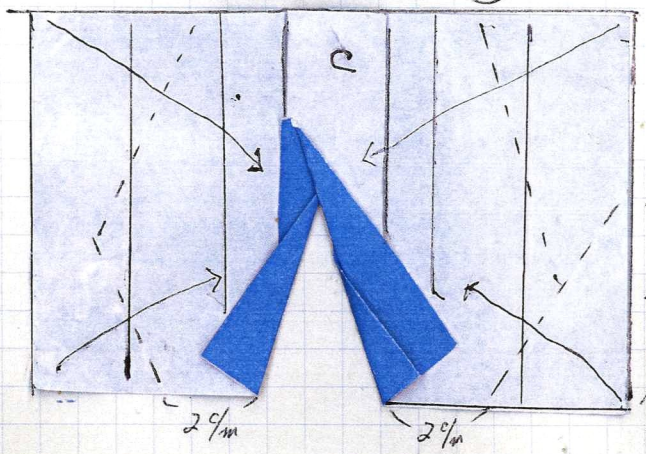

⑤



足 4 cm 角 2枚

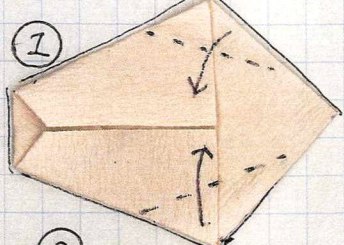

②

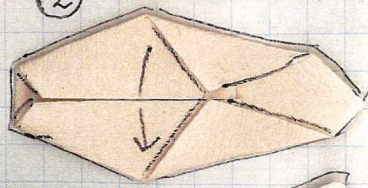

③

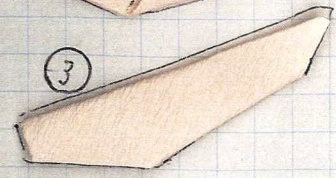

⑥



袴と足 (てまり)

(足)

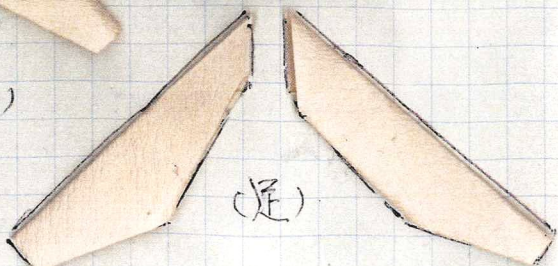

魚

15cm  $\frac{1}{2}$  二等辺三角形 (2枚)

No 2

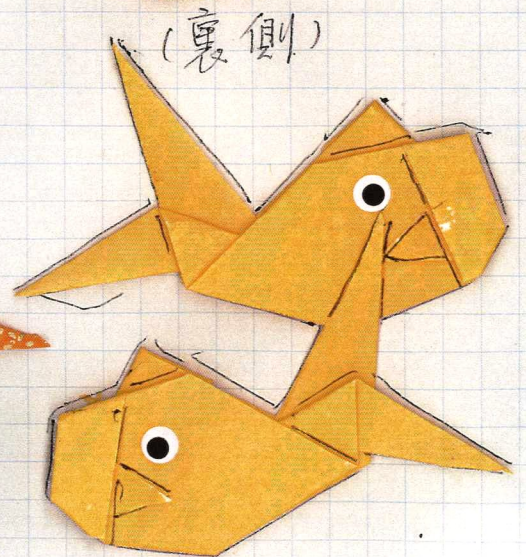
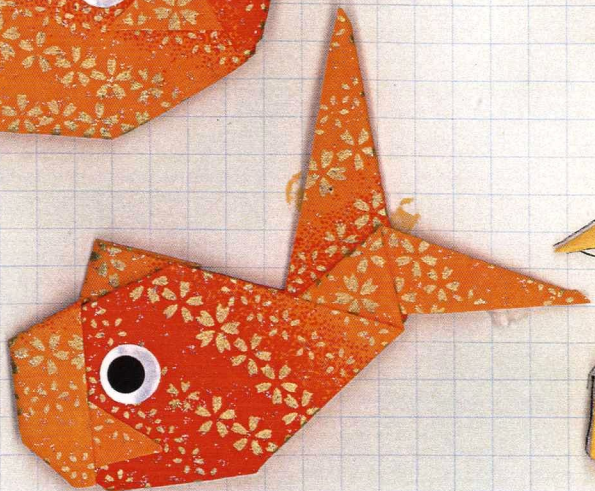
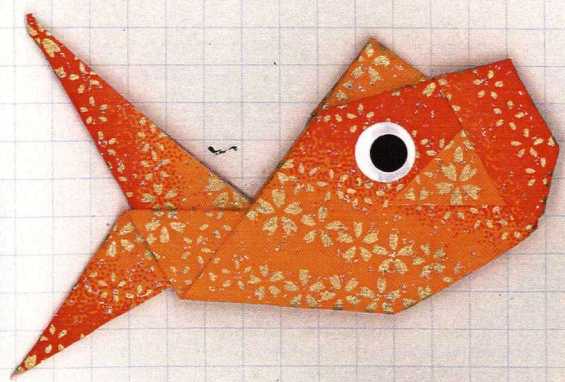
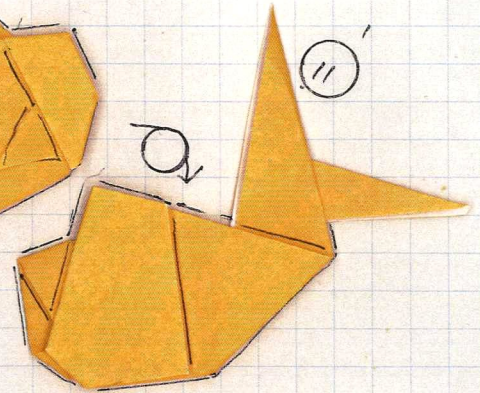
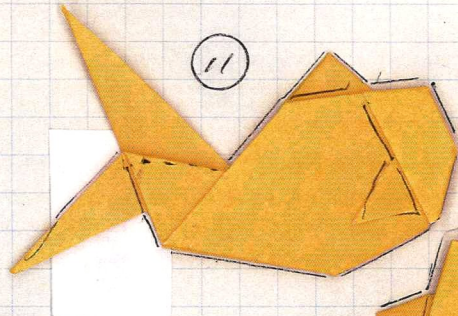
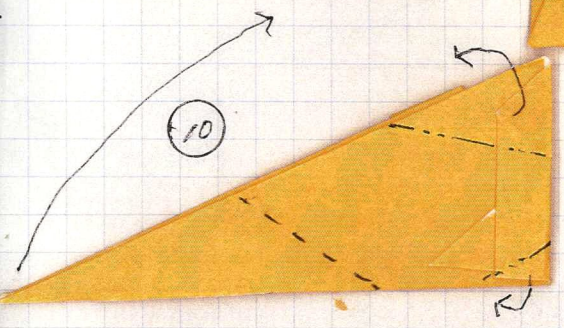
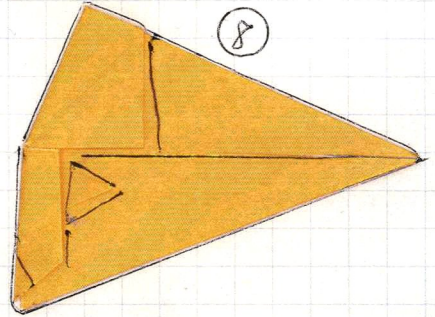
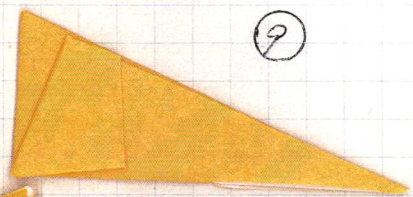
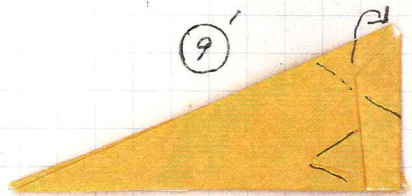
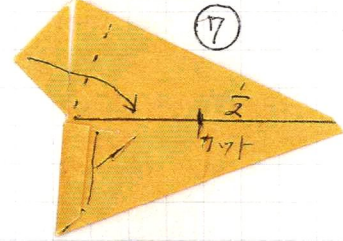
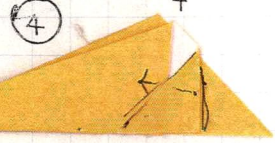
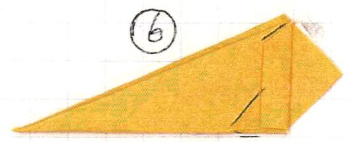
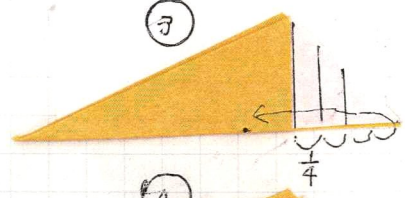
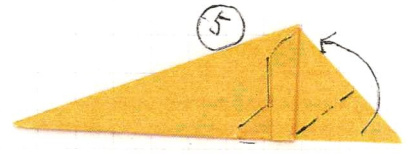
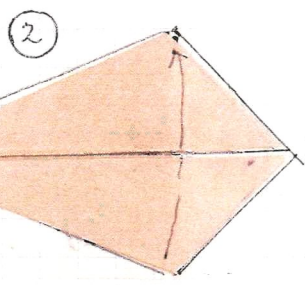
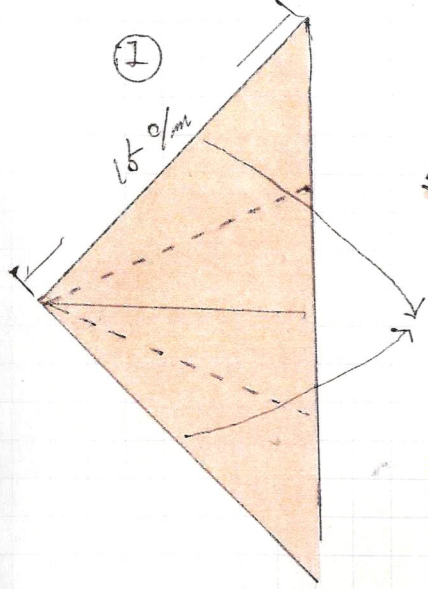

(裏側)

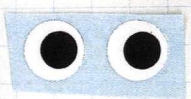

目 = シール

船体

15%角(1枚)

2

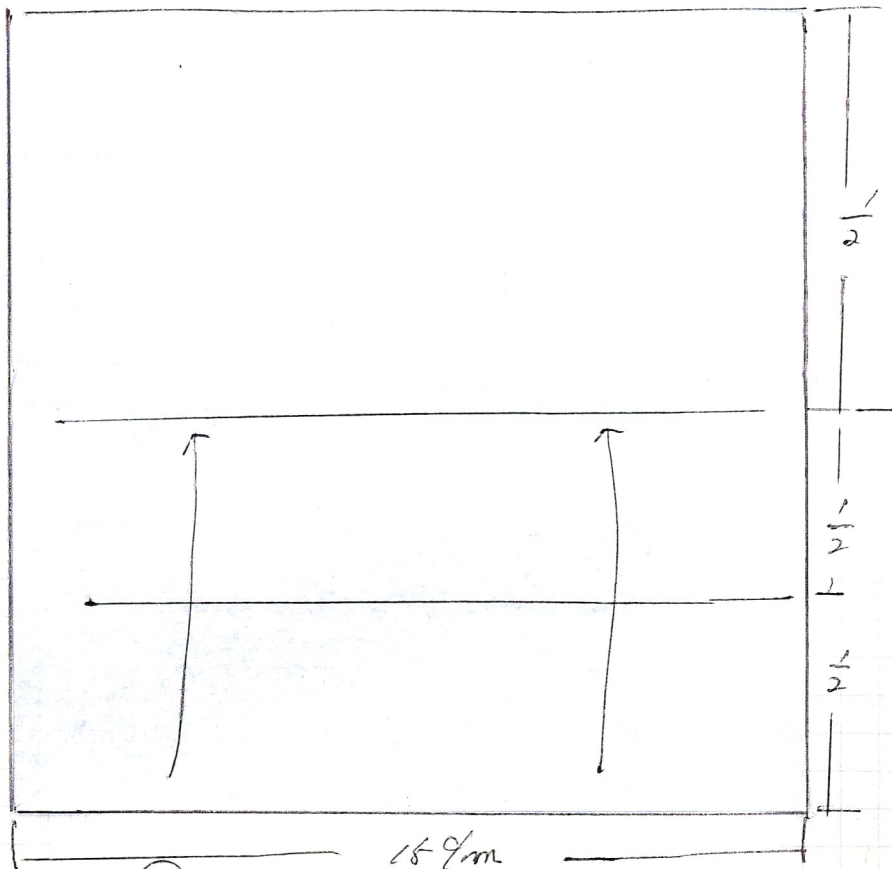

2

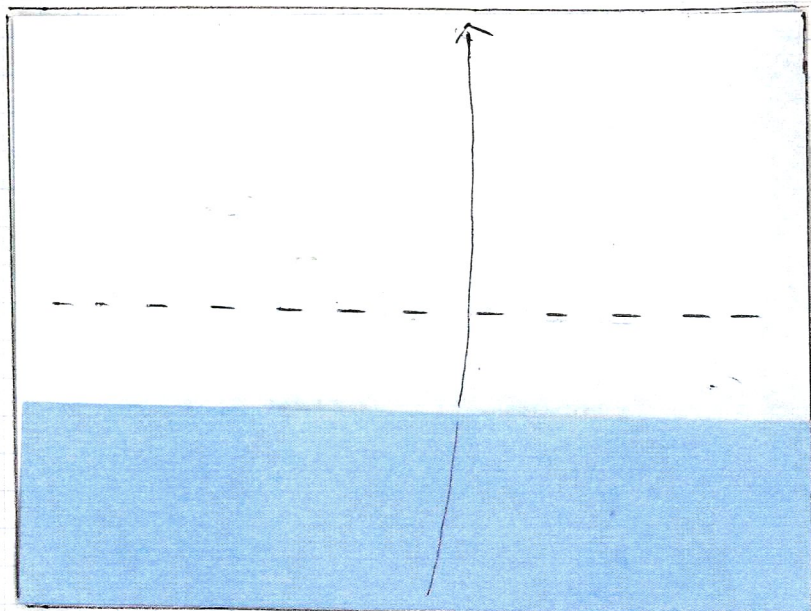

3

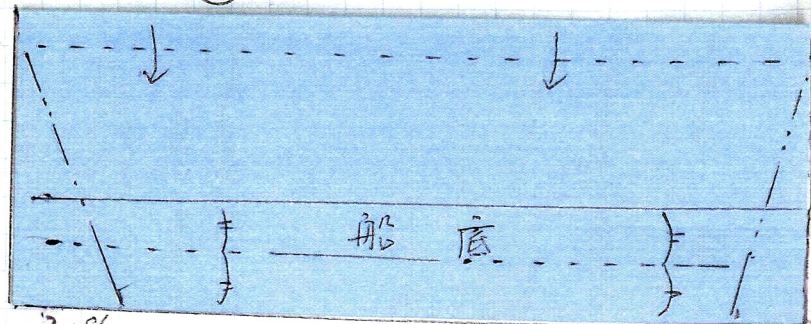

2.0% (カマ)

1.5% (カマ)

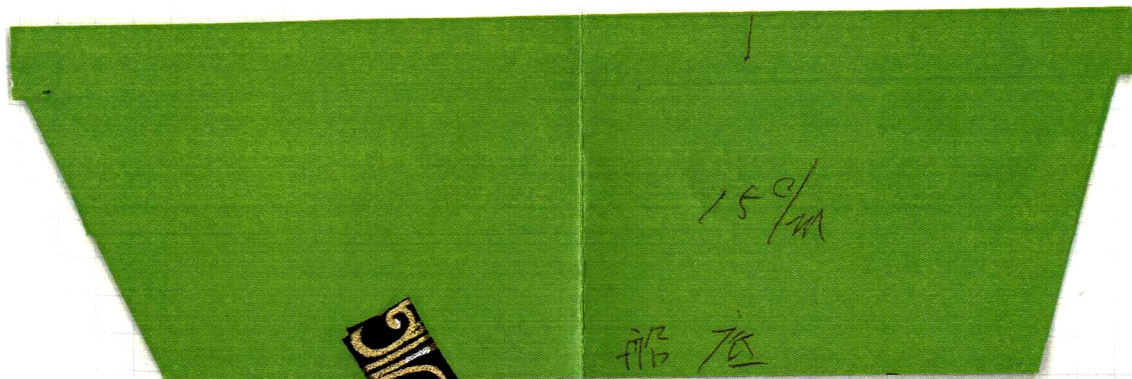

\* 24% = 21



5



4

